

Datumsuhren mit Höhenverstellung -

- Stelleinsatz verändert sich geringfügig in der Höhe bei Verdrehung
- Wanddickenänderung im Formteil

Typ B - erhm - Basismodell - erhabene Gravur

Einbaumaße (mm)

Gehäuse						Einsatz		Höhen-	Gravur-
d	k	g	t	s	u	Kopfdurchm.	Länge	differenz/	tiefe
						Einsatz	Einsatz	Umdrehung	Pfeil
16	33	M8	8	15	9	8,4	23	0,6	0,6
12	25	M6	6	11	6,6	6,4	17	0,5	0,6
10	20	M5	4	10	5,5	4,6	14	0,35	0,4
8	20	M4	4	8	4,5	4,6	14	0,35	0,4
6	17	M3	3,5	6,5	3,4	3,1	13	0,2	0,4
5	17	M3	3,5	6,5	3,4	3,1	13	0,2	0,4
4	14	M2	2,5	4,3	2,4	2,5	10,5	0,2	0,3

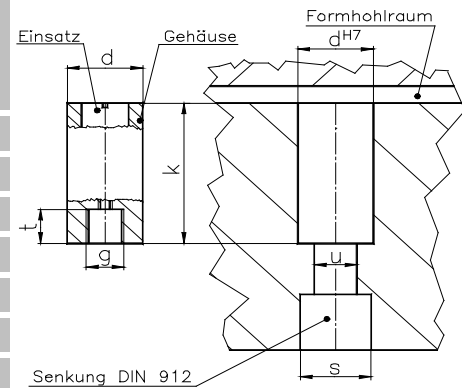

Typ MV-erhm - Montage von Vorne - erhabene Gravur

Einbaumaße (mm)

Gehäuse				Einsatz		Höhen-	Gravur-
d	k	g	t	Kopfdurchm.	Länge	differenz/	tiefe
				Einsatz	Einsatz	Umdrehung	Pfeil
16	33	M8	9,5	8,4	23	0,6	0,6
12	25	M6	9	6,4	17	0,5	0,6
10	20	M5	5,5	4,6	14	0,35	0,4
8	20	M4	5,5	4,6	14	0,35	0,4
6	17	M3	5,5	3,1	13	0,2	0,4
5	17	M3	5,5	3,1	13	0,2	0,4
4	14	M2	3,5	2,5	10,5	0,2	0,3

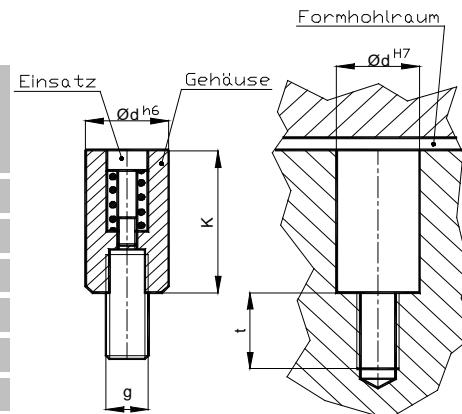

Wenn in Ihrer Bestellung nicht anders angegeben, liefern wir in Werkstoff 1.2344

erhabene Gravur

Typ BK - erhm - Basismodell - Kurz - erhabene Gravur

Einbaumaße (mm)

Gehäuse						Einsatz		Höhen- differenz/ Umdrehung	Gravur- tiefe Pfeil
d	k	g	t	s	u	Kopfdurchm. Einsatz	Länge Einsatz		
16	20	M5	4	10	5,5	8,2	14	0,35	0,6
12	20	M5	4	10	5,5	6,2	14	0,35	0,6
10	16	M5	4	10	5,5	5,2	12	0,35	0,4
8	14	M4	3	8	4,5	4,4	10	0,25	0,4
6	12	M3	3	6,5	3,4	3,1	8	0,2	0,4
5	12	M3	3	6,5	3,4	3,1	8	0,2	0,4
4	8	M2	2	4,3	2,4	2,1	4,8	0,25	0,3

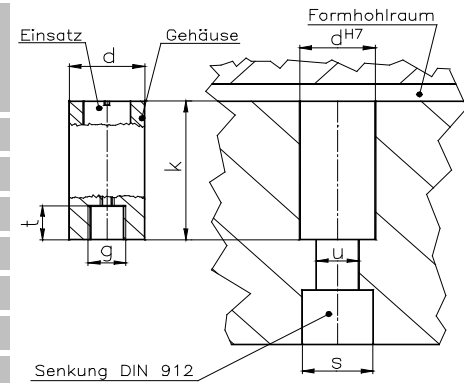







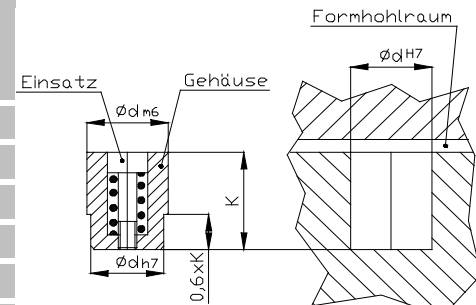

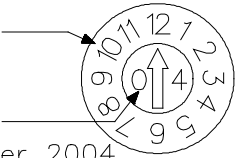

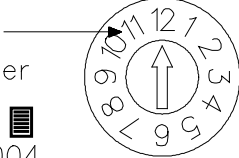
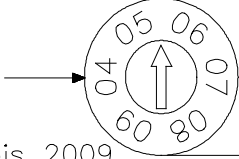
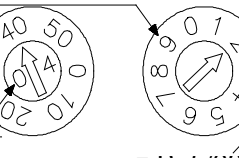
Typ K - erhm - kurze Ausführung - erhabene Gravur

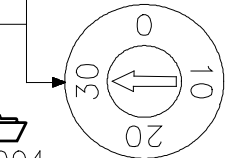
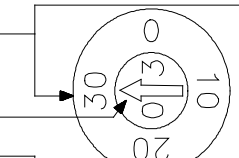
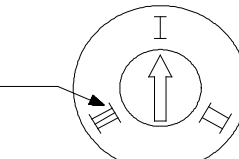
Einbaumaße (mm)

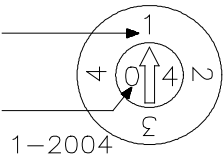
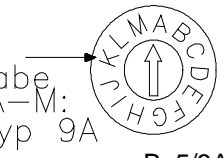
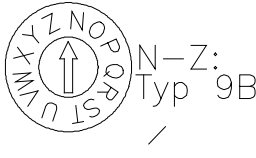

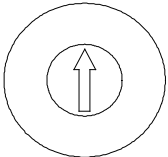

Gehäuse		Einsatz		Höhen- differenz/ Umdrehung	Gravur- tiefe Pfeil
d	k	Kopfdurchm. Einsatz	Länge Einsatz (-0,4)		
16	14	8,2	14	0,35	0,6
12	14	6,2	14	0,35	0,6
10	12	5,2	12	0,35	0,4
8	10	4,4	10	0,35	0,4
6	8	3,1	8	0,2	0,4
5	8	3,1	8	0,2	0,4
4	5	2,1	5	0,25	0,25



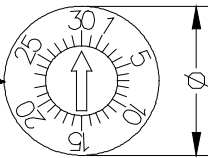
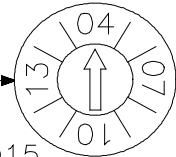
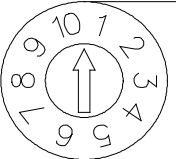
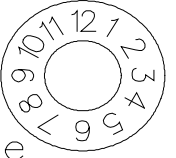
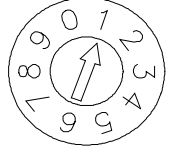
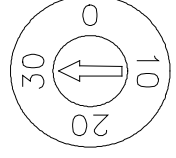
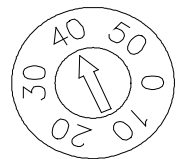

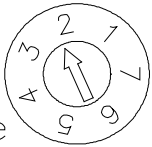
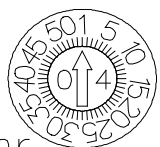
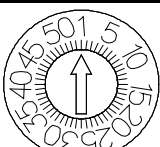
TYP-Nr.	INFORMATION	SCHRIFTBILD	erhabene Gravur			
			Bestell-Nummern	B oder MV	VA o.	
			Durchm. / JAHR / Typ-Nr.:	BK oder K	-erhm / WAS	
1-erhm	Monate Jahr z.B. Dezember 2004	 z.B. 5/08/1-B-erhm/WAS etc. z.B. 5/08/1-B-erhm/VA etc.	16 /	/ 1-		-erhm /
			12 /	/ 1-	B, MV, BK oder K	-erhm /
			10 /	/ 1-		-erhm /
			8 /	/ 1-		-erhm /
			6 /	/ 1-		-erhm /
			5 /	/ 1-		-erhm /
			4 /	/ 1-		-erhm /
2-erhm	Monate z.B. Dezember mit Typ-Nr.  z.B. Dez. 2004	 z.B. 5/2-B-erhm/WAS etc. z.B. 5/2-B-erhm/VA etc.	16 /	2-		-erhm /
			12 /	2-	B, MV, BK oder K	-erhm /
			10 /	2-		-erhm /
			8 /	2-		-erhm /
			6 /	2-		-erhm /
			5 /	2-		-erhm /
			4 /	2-		-erhm /
3-erhm	6 Jahre z.B. 2004 bis 2009	 z.B. 5/08/3-B-erhm/WAS etc. z.B. 5/08/3-B-erhm/VA etc.	16 /	/ 3-		-erhm /
			12 /	/ 3-	B, MV, BK oder K	-erhm /
			10 /	/ 3-		-erhm /
			8 /	/ 3-		-erhm /
			6 /	/ 3-		-erhm /
			5 /	/ 3-		-erhm /
			4 /	/ 3-		-erhm /
4-erhm	Wochen Jahr z.B. Woche 42/2004	 z.B. 5/08/4-B-erhm/WAS etc. z.B. 5/08/4-B-erhm/VA etc.	16 /	/ 4-		-erhm /
			12 /	/ 4-	B, MV, BK oder K	-erhm /
			10 /	/ 4-		-erhm /
			8 /	/ 4-		-erhm /
			6 /	/ 4-		-erhm /
			5 /	/ 4-		-erhm /
			4 /	/ 4-		-erhm /
5-erhm	Tage z.B. 31. Tag mit Typ-Nr.  z.B. 30.Dez.2004	 z.B. 5/5-B-erhm/VA etc.	16 /	5-		-erhm /
			12 /	5-	B, MV, BK oder K	-erhm /
			10 /	5-		-erhm /
			8 /	5-		-erhm /
			6 /	5-		-erhm /
			5 /	5-		-erhm /
			4 /	5-		-erhm /
6-erhm	Tage Monate Jahr z.B. 30.03.2004 inkl. 12 Stk. Wechseleinsätze	 z.B. 5/08/6-B-erhm/VA etc.	16 /	/ 6-		-erhm /
			12 /	/ 6-	B, MV, BK oder K	-erhm /
			10 /	/ 6-		-erhm /
			8 /	/ 6-		-erhm /
			6 /	/ 6-		-erhm /
			5 /	/ 6-		-erhm /
			4 /	/ 6-		-erhm /
7-erhm	Schicht z.B. Schicht I	 z.B. 5/7-B-erhm/VA etc.	16 /	7-		-erhm /
			12 /	7-	B, MV, BK oder K	-erhm /
			10 /	7-		-erhm /
			8 /	7-		-erhm /
			6 /	7-		-erhm /
			5 /	7-		-erhm /
			4 /	7-		-erhm /

TYP-Nr.	INFORMATION	SCHRIFTBILD	erhabene Gravur			
			Bestell-Nummern	B oder MV	VA o.	
			Durchm. / JAHR /	Typ-Nr.: BK oder K	-erhm /	WAS
8-erhm	Quartal Jahr z.B. Quartal 1-2004		16 /	/ 8-	B, MV, BK oder K	-erhm /
			12 /	/ 8-		-erhm /
			10 /	/ 8-		-erhm /
			8 /	/ 8-		-erhm /
			6 /	/ 8-		-erhm /
			5 /	/ 8-		-erhm /
			4 /	/ 8-		-erhm /
9A-erhm	Kenn- Buchstabe A-M: Typ 9A		16 /	9A	B, MV, BK oder K	-erhm /
			12 /	9A		-erhm /
			10 /	9A		-erhm /
			8 /	9A		-erhm /
			6 /	9A		-erhm /
			5 /	9A		-erhm /
			4 /	9A		-erhm /
9B-erhm			16 /	9B	B, MV, BK oder K	-erhm /
			12 /	9B		-erhm /
			10 /	9B		-erhm /
			8 /	9B		-erhm /
			6 /	9B		-erhm /
			5 /	9B		-erhm /
			4 /	9B		-erhm /
10-erhm	Einsatz Pfeil und Jahresangabe z.B. 5/08/10-B-erhm/WAS etc. z.B. 5/08/10-B-erhm/VA etc.		16 /	/ 10-	B, MV, BK oder K	-erhm /
			12 /	/ 10-		-erhm /
			10 /	/ 10-		-erhm /
			8 /	/ 10-		-erhm /
			6 /	/ 10-		-erhm /
			5 /	/ 10-		-erhm /
			4 /	/ 10-		-erhm /
11-erhm	Einsatz nur Pfeil z.B. 5/11-B-erhm/WAS etc. z.B. 5/11-B-erhm/VA etc.		16 /	11-	B, MV, BK oder K	-erhm /
			12 /	11-		-erhm /
			10 /	11-		-erhm /
			8 /	11-		-erhm /
			6 /	11-		-erhm /
			5 /	11-		-erhm /
			4 /	11-		-erhm /
12-erhm	Beschriftung: 01-99 A-Z Einsatz mit Buchstaben- oder Zahl z.B. 5/08/12-B-erhm/WAS etc. z.B. 5/08/12-B-erhm/VA etc.	 	16 /	/ 12-	B, MV, BK oder K	-erhm /
			12 /	/ 12-		-erhm /
			10 /	/ 12-		-erhm /
			8 /	/ 12-		-erhm /
			6 /	/ 12-		-erhm /
			5 /	/ 12-		-erhm /
			4 /	/ 12-		-erhm /
13-erhm			16 /	13-	B, MV, BK oder K	-erhm /
			12 /	13-		-erhm /
			10 /	13-		-erhm /
			8 /	13-		-erhm /
			6 /	13-		-erhm /
			5 /	13-		-erhm /
			4 /	13-		-erhm /
14-erhm	Gravur auf Wunsch z.B. 5/PA6.6.-PA6.6-GF30/14-B-erhm/VA etc.		16 /	/ 14-	B, MV, BK oder K	-erhm /
			12 /	/ 14-		-erhm /
			10 /	/ 14-		-erhm /
			8 /	/ 14-		-erhm /
			6 /	/ 14-		-erhm /
			5 /	/ 14-		-erhm /
			4 /	/ 14-		-erhm /

TYP-Nr.	INFORMATION	SCHRIFTBILD	erhabene Gravur				
			Bestell-Nummern	B oder MV	VA o.		
			Durchm. / JAHR / Typ-Nr.:	BK oder K	-erhm /	WAS	
15-erhm	31 Tage →	 <p>NEU: Kosten- u. Platzsparende Alternative siehe Typ 27</p> <p>z.B. 5/15-B-erhm/WAS etc. z.B. 5/15-B-erhm/VA etc.</p>	16 /	15-	B, MV, BK oder K	-erhm /	VA o. WAS
			12 /	15-		-erhm /	
			10 /	15-		-erhm /	
			8 /	15-		-erhm /	
			6 /	15-		-erhm /	
			5 /	15-		-erhm /	
16-erhm	12 Jahre → z.B. 2004 bis 2015	 <p>z.B. 5/08/16-B-erhm/WAS etc. z.B. 5/08/16-B-erhm/VA etc.</p>	16 /	/ 16-	B, MV, BK oder K	-erhm /	VA o. WAS
			12 /	/ 16-		-erhm /	
			10 /	/ 16-		-erhm /	
			8 /	/ 16-		-erhm /	
			6 /	/ 16-		-erhm /	
			5 /	/ 16-		-erhm /	
17-erhm		 <p>z.B. 5/17-B-erhm/WAS etc. z.B. 5/17-B-erhm/VA etc.</p>	16 /	17-	B, MV, BK oder K	-erhm /	VA o. WAS
			12 /	17-		-erhm /	
			10 /	17-		-erhm /	
			8 /	17-		-erhm /	
			6 /	17-		-erhm /	
			5 /	17-		-erhm /	
18-erhm	nur Gehäuse	 <p>z.B. 5/18-B-erhm/WAS etc. z.B. 5/18-B-erhm/VA etc.</p>	16 /	18-	B, MV, BK oder K	-erhm /	VA o. WAS
			12 /	18-		-erhm /	
			10 /	18-		-erhm /	
			8 /	18-		-erhm /	
			6 /	18-		-erhm /	
			5 /	18-		-erhm /	
19-erhm		 <p>z.B. 5/19-B-erhm/WAS etc. z.B. 5/19-B-erhm/VA etc.</p>	16 /	19-	B, MV, BK oder K	-erhm /	VA o. WAS
			12 /	19-		-erhm /	
			10 /	19-		-erhm /	
			8 /	19-		-erhm /	
			6 /	19-		-erhm /	
			5 /	19-		-erhm /	
20-erhm		 <p>z.B. 5/20-B-erhm/WAS etc. z.B. 5/20-B-erhm/VA etc.</p>	16 /	20-	B, MV, BK oder K	-erhm /	VA o. WAS
			12 /	20-		-erhm /	
			10 /	20-		-erhm /	
			8 /	20-		-erhm /	
			6 /	20-		-erhm /	
			5 /	20-		-erhm /	
21-erhm		 <p>z.B. 5/21-B-erhm/WAS etc. z.B. 5/21-B-erhm/VA etc.</p>	16 /	21-	B, MV, BK oder K	-erhm /	VA o. WAS
			12 /	21-		-erhm /	
			10 /	21-		-erhm /	
			8 /	21-		-erhm /	
			6 /	21-		-erhm /	
			5 /	21-		-erhm /	

TYP-Nr. INFORMATION		SCHRIFTBILD	erhabene Gravur				
			Bestell-Nummern	B oder MV	VA o.		
			Durchm. / JAHR / Typ-Nr.	BK oder K	-erhm /	WAS	
22-erhm	Wochentage	 <p>z.B. 5/22-B-erhm/WAS etc. z.B. 5/22-B-erhm/VA etc.</p>	16 /	22-		-erhm /	VA o. WAS
			12 /	22-	B, MV, BK oder K	-erhm /	
			10 /	22-		-erhm /	
			8 /	22-		-erhm /	
			6 /	22-		-erhm /	
			5 /	22-		-erhm /	
			4 /	22-		-erhm /	
23-erhm	Wochen/Jahr	 <p>z.B. 5/08/23-B-erhm/WAS etc. z.B. 5/08/23-B-erhm/VA etc.</p>	16 /	/ 23-		-erhm /	VA o. WAS
			12 /	/ 23-	J A H R	-erhm /	
			10 /	/ 23-		-erhm /	
			8 /	/ 23-		-erhm /	
			6 /	/ 23-		-erhm /	
			5 /	/ 23-		-erhm /	
			4 /	/ 23-		-erhm /	
24-erhm	Wochen	 <p>z.B. 5/24-B-erhm/WAS etc. z.B. 5/24-B-erhm/VA etc.</p>	16 /	24-		-erhm /	VA o. WAS
			12 /	24-	B, MV, BK oder K	-erhm /	
			10 /	24-		-erhm /	
			8 /	24-		-erhm /	
			6 /	24-		-erhm /	
			5 /	24-		-erhm /	
			4 /	24-		-erhm /	
Musterregister: 40403550.7	25-erhm	 <p>Wichtig !! Auf Einsatz mit Körner Jahre kennzeichnen</p> <p>z.B. 5/08/25-B-erhm/WAS etc. z.B. 5/08/25-B-erhm/VA etc.</p>	16 /	/ 25-		-erhm /	VA o. WAS
			12 /	/ 25-	J A H R	-erhm /	
			10 /	/ 25-		-erhm /	
			8 /	/ 25-		-erhm /	
			6 /	/ 25-		-erhm /	
			5 /	/ 25-		-erhm /	
						-erhm /	
Musterregister: 40403550.7	26-erhm	 <p>Wichtig !! Auf Einsatz mit Körner Wochen kennzeichnen</p> <p>z.B. 8/08/26-B-erhm/WAS etc. z.B. 8/08/26-B-erhm/VA etc.</p>	16 /	/ 26-		-erhm /	VA o. WAS
			12 /	/ 26-	J A H R	-erhm /	
			10 /	/ 26-		-erhm /	
			8 /	/ 26-		-erhm /	
			6 /	/ 26-		-erhm /	
			5 /	/ 26-		-erhm /	
						-erhm /	
Musterregister: 40301203.1	27-erhm	 <p>Wichtig !! Auf Einsatz mit Körner Monate kennzeichnen</p> <p>z.B. 5/08/27-B-erhm/WAS etc. z.B. 5/08/27-B-erhm/VA etc.</p>	16 /	/ 27-		-erhm /	VA o. WAS
			12 /	/ 27-	J A H R	-erhm /	
			10 /	/ 27-		-erhm /	
			8 /	/ 27-		-erhm /	
			6 /	/ 27-		-erhm /	
			5 /	/ 27-		-erhm /	
						-erhm /	
Musterregister: 40403550.7	28-erhm	 <p>Wichtig !! Auf Einsatz mit Körner Jahre kennzeichnen</p> <p>z.B. 5/08/28-B-erhm/WAS etc. z.B. 5/08/28-B-erhm/VA etc.</p>	16 /	/ 28-		-erhm /	VA o. WAS
			12 /	/ 28-	J A H R	-erhm /	
			10 /	/ 28-		-erhm /	
			8 /	/ 28-		-erhm /	
			6 /	/ 28-		-erhm /	
			5 /	/ 28-		-erhm /	
						-erhm /	

TYP-Nr.	INFORMATION	SCHRIFTBILD	erhabene Gravur					
Musterregister: 40403550.7	 <p>29-erhm</p> <p>NEU ! Stelleinsatz für Typ 26</p>	<p>Wichtig !! Auf Einsatz mit Körner Wochen kennzeichnen</p> <p>z.B. 8/08/29-B-erh/WAS etc. z.B. 8/08/29-B-erh/VA etc.</p>	Bestell-Nummern		B oder MV	VA o.		
			Durchm. /	JAHR /	Typ-Nr.	BK oder K	-erhm /	WAS
			16 /	/	29-	B, MV, BK oder K	-erhm /	VA o. WAS
			12 /	/	29-		-erhm /	
			10 /	/	29-		-erhm /	
			8 /	/	29-		-erhm /	
			6 /	/	29-		-erhm /	
	5 /	/	29-	-erhm /				
Musterregister: 40301203.1	 <p>30-erhm</p> <p>NEU ! Stelleinsatz für Typ 27</p>	<p>Wichtig !! Auf Einsatz mit Körner Monate kennzeichnen</p> <p>z.B. 5/08/30-B-erh/WAS etc. z.B. 5/08/30-B-erh/VA etc.</p>	Bestell-Nummern		B oder MV	VA o.		
			Durchm. /	JAHR /	Typ-Nr.	BK oder K	-erhm /	WAS
			16 /	/	30-	B, MV, BK oder K	-erhm /	VA o. WAS
			12 /	/	30-		-erhm /	
			10 /	/	30-		-erhm /	
			8 /	/	30-		-erhm /	
			6 /	/	30-		-erhm /	
	5 /	/	30-	-erhm /				

Zubehör

Schraubenzieher Klinge hochwertiger Chrom-Vanadium-Molybdän-Stahl durchgehend gehärtet, mattverchromt

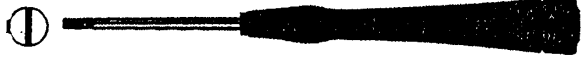
	Für Datumsuhr	Klingenlänge	Bestell-Nummer
	16	5,5 mm	127
	12	4 mm	497
	10	3 mm	490
	8	3 mm	490
	6	2,5 mm	486
	5	2,5 mm	486
	4	2,0 mm	482

Zylinderschraube mit Innensechskant DIN 912

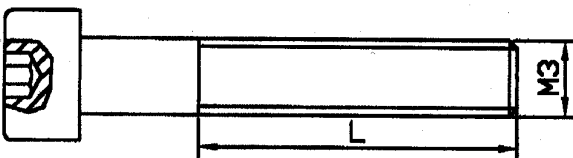
 <p>Beispiel: M3 x 20 DIN 912</p>	Für Datumsuhr	Bestell-Nummer
	16	M8 x L
	12	M6 x L
	10	M5 x L
	8	M4 x L
	6	M3 x L
	5	M3 x L
	4	M2 x L

Preise netto